

SINGER

66K

No.	Plate						
32507	1544	Feed Bar with 1944
1944	1546	" " Roller and Stud
315c	1731	" " Screw Centre (2)
1519j	1546	" " " " Nut (2)
32502	1545	" Cam with 1285c
1285c	1546	" " Set Screw
32600	733	Feed Dog
191k	1731	" " Screw
32620	724	Feed Forked Connection with 175j
175j	1731	" " " Adjusting Screw
1381c	1731	" " " Hinge Screw (eccentric)
1520j	1546	" " " " " Nut
1832	1546	" " " Roller with 1085e
1085e	1731	" " " " Screw Stud
32510	1544	" Raising Bar with 1944
1301c	1731	" " " Hinge Screw
1944	1546	" " " Roller and Stud
253b	1546	" Regulating Thumb Screw
8216	1544	" Regulator
8217	1543	" " Friction Washer
42c	1731	" " Hinge Screw
32581	1542	Feed Rock Shaft
307c	1731	" " " Screw Centre (2)
1513j	1546	" " " " " Nut (2)
51045c	1545	Machine Hinge Connection Set Screw (2)
32668	1543	Needle Bar with 32519
66558	1543	" " Bushing
66655	—	" " " 66558 with 665b and 66639
1133c	1546	" " " Set Screw
32515	1544	" " Connecting Link with 51002e
32669	—	" " " " 32515 with 66559
32670	—	" " " " 32669 with 1130e and 32578
51002e	1546	" " " " Adjusting Screw
1130e	1546	" " " " Cap Screw
66559	1543	" " " Stud with 1353c
1353c	1731	" " " " Set Screw
32517	1544	" " Crank with 1036c and 1134c
1134c	1731	" " " Position Screw
21360	1543	" " Hole Plug
66639	1543	" " Thread Guard
665b	1546	" " " Screw
66561	1543	" " Timing Gauge
2054	1538	" Clamp with 552r
552r	1731	" " Thumb Screw
32519	1538	" Stop Pin

No.	Plate						
32520	955	Oscillating Hook
32626	—	" " 32520 with 32590
32656	1544	" " Bell Crank
50561c	1546	" " " " Hinge Screw
32522	1538	" " Bobbin
32590	955	" " " Case with 1172f, 1173d and 32567
32661	1538	" " " Cushion Spring
662d	1731	" " " " " Screw
32659	1538	" " " " Position Bracket
32662	1538	" " " " " Hinge Stud
50611j	1731	" " " " " " " Set Screw
32663	1538	" " " " " Latch
50579d	1731	" " " " " Screw
32598	955	" " " " " Oil Pad (Felt)
32599	955	" " " " " " " Holder
32660	—	" " " " " complete, Nos.
		662d, 32528, 32598, 32599, 32659, 32660 to 32664, 50579d
		and 50580e
1172i	1731	Oscillating Hook Bobbin Case Tension Regulating Screw
32567	955	" " " " " Spring	
1173d	1731	" " " " " Screw	
32664	1538	" " " Ejector	
50580e	1731	" " " " Hinge Screw Stud	
32528	1543	" " " " Spring	
32529	1544	" " Connecting Link	
1132c	1731	" " " " Hinge Screw	
32594	1544	" " Crank with 1485c	
1485c	955	" " " Clamping Screw	
32531	724	" " Pitman with two 175j	
175j	1731	" " " Adjusting Screw	
11c	1731	" " " Hinge Screw	
1216c	1731	" " " Screw Stud	
1520j	1546	" " " " " Nut	
216c	1731	" " " " " Screw	
32569	1543	" " Slide	
32570	1543	" " " Friction Spring	
226d	1731	" " " " " Screw	
32665	1542	Presser Bar	
32535	1545	" " Guide Bracket with 453c	
453c	1731	" " " " Set Screw	
66564	1545	" " Lifter	
85e	1546	" " " Screw	
32675	1545	" " Spring	
2070	1543	" " " Washer	

From the library of Diamond Needle Corp

No.	Plate							
32666	1543	Presser Foot
51224b	1545	"	"	Thumb Screw
263j	1546	Pressure Regulating Thumb Screw
32621	955	Slack Thread Regulator
219e	1546	"	"	"	Screw
2102	1538	Tension Disc
1560g	1731	"	"	Regulating Thumb Nut
32572	1538	"	"	Releasing Disc
32573	1543	"	"	Lever
97e	1546	"	"	"	Hinge Screw
12329	1543	"	"	"	Spring
32571	1538	"	"	Pin
1274b	1731	"	"	Screw Stud
8238	1538	"	"	Spring
32654	—	Tension, complete, Nos. 1274b, 1560g, 8238, 32572, 32571 to 32576 and two 2102
26075	1538	Thread Cutter and Holder
8422	1538	"	"	Guard (for head of arm)
32578	1544	"	"	Take-up Crank
1036c	1731	"	"	"	Set Screw
32541	1544	"	"	Lever
32542	—	"	"	"	complete, Nos. 32541, 32543 and 32544
32671	—	"	"	"	32542 with 1131c and 32670
32543	1543	"	"	"	Hinge Stud
32544	1544	"	"	"	Link
1131c	1546	"	"	"	"	Hinge Screw
32575	1538	"	"	"	Spring
32576	1538	"	"	"	Regulator
453e	1731	"	"	"	"	Set Screw
32602	733	Throat Plate for 32600
691a	1731	"	"	"	Screw (2)
93215	—	Drip Pan (for Machine on Cover Set)
*15404	—	Trade Mark
15405	—	"	"	"	Rivet

Bobbin Winder (Automatic)

FOR USE WITH BALANCE WHEEL No. 15282.

No.	Plate							
15376	1124	Adjusting Arm
50058b	1731	"	"	"	Screw
15072	1548	Bobbin Position Pin
‡32604	—	Bracket (Belt Cover)
180b	1731	"	"	"	Screw
15413	1124	Frame
32655	—	"	15413 with 571c, 15288 and 32550
50059b	1731	"	"	"	Hinge Screw
15286	1548	"	"	"	Spring
15287	1548	Friction Ring (Rubber)
15288	1548	Pulley
32550	1548	Spindle with 15072
571c	1731	"	"	"	Worm
32625	1124	Stop Latch
50230b	1124	"	"	"	Hinge Screw
15291	1548	"	"	"	Spring
32628	1124	Thread Guide
50061b	1731	"	"	"	Hinge Screw
15366	1548	"	"	"	Spring
15416	1124	Worm Wheel and Thread Guide Cam
2749	1548	"	"	"	"	"	"	Friction Washer
50b	1731	"	"	"	"	"	"	Screw Stud
1528j	1731	"	"	"	"	"	"	Nut
‡32629	1124	Bobbin Winder (automatic), complete, Nos. 50b, 1528j, 2749, 15286, 15287, 15291, 15366, 15376, 15416, 32604, 32625, 32628, 32655, 50058b, 50059b, 50061b and 50230b

Bobbin Winder (Automatic)

FOR USE WITH BALANCE WHEEL No. 32672.

This Bobbin Winder is the same as No. 32629 with the following exceptions:

No.	Plate							
32673	—	Bracket (Belt Cover)
32674	—	Bobbin Winder (automatic), complete, Nos. 50b, 1528j, 2749, 15286, 15287, 15291, 15366, 15376, 15416, 32625, 32628, 32655, 32673, 50058b, 50059b, 50061b and 50230b

‡ In ordering it is necessary to state whether Egyptian or 99K design ornamentation is required.

Attachment Set

No.	Plate	
121464	930	Binder
25527b	2397	Cloth Guide
50053b	2397	" " Thumb Screw
35931	930	Hemmer (adjustable)
120842	733	" (Foot) $\frac{5}{16}$ " Hem
15 x 1		Needles (6)
120862		Tin of Oil (1 $\frac{1}{4}$ oz.)
32522	1538	Oscillating Hook Bobbin
25537	2397	Screw Driver (machine)
120378	2397	" " (bobbin case)
36583	1160	Tucker
86504	—	Set , complete, Nos. 25527b, 25537, 35931, 36583, 50053b, 120378, 120842, 120862 121464, three 32522 and six needles
25525	2397	Bias Gauge
15429	1151	Presser Foot for Stitching on Edge and Inserting Cord (needle hole on right hand side)
86602	2398	Presser Foot for Stitching on Edge and Inserting Cord (needle hole on left hand side)
121441	2398	Gathering Foot (double toe)
120687	1151	Imitation Hemstitching Attachment with Yielding Presser Plate
35932	930	Quilter
120290	930	Ruffler
121170	2397	" Shirring Plate
25539	2397	Stiletto
121547	2397	Under Braider

Art Work and Darning

DARNING PRESSER

No.	Plate	
86493	1160	Needle Clamp with 552k
552k	1160	" " Screw
86494	1160	" " Stripper Spring
86495	1160	" " " " Eyelet
86496	1160	Darning Presser, complete, Nos. 86493 to 86495
121094	2398	Spring Darning Foot
32582	2398	Feed Cover Plate with 1423b and 32583
32583	2398	" " " Position Stud
1423b	2398	" " " Screw
32622	2398	Feed Cover Plate
85893	1151	Presser Foot for Etching

Tubular Trimming Attachment

FOR MAKING $\frac{3}{32}$ ", $\frac{1}{8}$ " and $\frac{5}{32}$ " TRIMMINGS

No.	Plate	
35984	1151	Presser Foot (strip folding) with Tube
25539	816	Stiletto
35983	1151	Strip Wire
35985	1151	Tubular Trimming Attachment , complete, Nos. 25539, 35983 and 35984

NOTE. When ordering 35983 state size of Attachment with which it is to be used.

NOTE. When ordering 35985 state size required.

From the library of Diamond Needle Corp

Embroidery Hoops (Plain)

(BIRCH)

No.	Plate						
87586	--	Round, 5 $\frac{3}{8}$ " diam. \times 7 $\frac{m}{m}$ " high
96416	--	" 7" " \times 7 $\frac{m}{m}$ " "
87589	1221	" 8" " \times 7 $\frac{m}{m}$ " "
87593	---	" 10" " \times 7 $\frac{m}{m}$ " "
87595	---	" 12" " \times 7 $\frac{m}{m}$ " "
96422	1221	Oval, 9" \times 4 $\frac{1}{2}$ " \times 7 $\frac{m}{m}$ " high
87597	---	" 12" \times 5 $\frac{1}{2}$ " \times 7 $\frac{m}{m}$ " "

Embroidery Hoops (with Clamp)

(BIRCH)

No.	Plate						
96417	---	Round, 5 $\frac{3}{8}$ " diam. \times 7 $\frac{m}{m}$ " high, with SS528j, NX95j, two	96425				
		and four	96427				
96418	---	" 7" " \times 7 $\frac{m}{m}$ " " " SS528j, NX95j, two	96426				
		and four	96427				
96419	---	" 8" " \times 7 $\frac{m}{m}$ " " " SS528j, NX95j, two	96426				
		and four	96427				
96420	---	" 10" " \times 7 $\frac{m}{m}$ " " " SS528j, NX95j, two	96426				
		and four	96427				
96421	---	" 12" " \times 7 $\frac{m}{m}$ " " " SS528j, NX95j, two	96844				
		and four	96845				
96423	---	Oval, 9" \times 4 $\frac{1}{2}$ " \times 7 $\frac{m}{m}$ " high, with SS528j, NX95j, 96425, 96426 and	96427				
		four	96427				
96424	---	" 12" \times 5 $\frac{1}{2}$ " \times 7 $\frac{m}{m}$ " " " SS528j, NX95j, 96425, 96426 and	96427				
		four	96427				
96425	2399	Clamping Bracket for 96417, 96423 and 96424	...				
96426	2399	" " " 96418 to 96420, 96423 and 96424	...				
96844	2399	" " " 96421	...				
96427	2399	" " " Rivet for 96417 to 96420, 96423 and 96424	...				
96845	2399	" " " " 96421	...				
SS528j	2399	" " " Screw	...				
NX95j	2399	" " " Nut	...				

Hand Attachment

No.	Plate						
†94050	2284	Body
94027	2284	" Bracket
183e	2114	" " Screw
94028	2114	Crank Handle (wood)
94029b	2114	" " Spindle
94030b	2114	" " " Flange (loose)
94069	2114	" Hinge Pin
94031a	2284	" Lever
94032	2114	" " Lock Pin
94033b	2114	" " " Head
55531	2114	" " " " Spring
94034b		Crank Complete, Nos. 94028, 94029b, 94030b and 94031a
94016	2114	Driver
94070		" 94016 with 80028 and 94048
94036	2114	" Finger
94039	2114	" " Driving Pad (raw hide)
94040	2114	" " " " Plate
SS567e	2114	" " " " and Plate Binding Screw
94041		" " 94036 with SS567e, 94039 and 94040
94044	2114	" " Hinge Pin
94037	2114	" " Latch
SS565e	2114	" " " Screw Stud
94038	2114	" " " Spring
94051b	2284	Gear with 55531, 94032 and 94033b
94016	2284	" Cover
399a	2114	" " Screw
SS599f	2114	" Screw Stud
94048	2114	Pinion
80028	2114	" Dowel Pin
SS600f	2114	" Screw Stud (eccentric)
†94052b	2284	Hand Attachment, complete, Nos. SS565e, SS566e, SS599f, SS600f, 94016, 94027, 94034b, 94037, 94038, 94041, 94044, 94050, 94051b, 94069, 94070 two each 183e and 399a
SS566e	2114	Hand Attachment Screw

From the library of Diamond Needle Corp

*In ordering it is necessary to state Class of Machine.

Obsolete Parts

No.	Plate							
32513	1986	Needle Bar
32514	1986	" "	Bushing
32580	1986	" "	Connecting Stud
32593	1986	Oscillating Hook Bobbin Case Cushion Spring
32591	1986	" "	" "	Position Bracket
32592	---	" "	" "	" "	Complete
142d	1986	" "	" "	" "	Screw
32527	1986	" "	" "	Ejector
1137e	1986	" "	" "	" "	Hinge Screw
32521	1986	" "	" "	Bell Crank
1135j	1986	" "	" "	" "	Stud
1642b	1986	" "	" "	" "	Collar with 165k
165k	1986	" "	" "	" "	Set Screw
32558	1986	Presser Bar
32601	1986	" "	Foot
32560	1986	" "	" "	Holder
1155b	1986	" "	" "	" "	Screw
1158b	1986	" "	" "	Thumb Screw

Numerical List of Parts

No.	Plate				
42c	1731	Feed Regulator Hinge Screw
44c	1731	Oscillating Hook Pitman Hinge Screw
50b	1731	Bobbin Winder Worm Wheel and Thread Guide Cam Screw Stud for 32629 and 32674
85c	1546	Presser Bar Lifter Screw
NX95j	2399	Embroidery Hoop Clamping Bracket Screw Nut for 96417 to 96421, 96423 and 96424
97e	1546	Tension Releasing Lever Hinge Screw
107b	1546	Face Plate Screw
112d	1986	Oscillating Hook Bobbin Case Position Bracket Screw	(Obsolete)
175j	1731	Feed Forked Connection Adjusting Screw for 32620
175j	1731	Oscillating Hook Pitman Adjusting Screw for 32531
180b	1731	Bobbin Winder Bracket Screw
183c	1731	Hand Attachment Body Bracket Screw for 94052b
191k	1731	Feed Dog Screw
216c	1731	Oscillating Hook Pitman Screw Stud Screw
219c	1546	Slack Thread Regulator Screw
226d	1731	Oscillating Hook Slide Friction Spring Screw
248a	1731	Clamp Stop Motion Clamp Stop Screw for 32619
253b	1546	Feed Regulating Thumb Screw
256b	1731	Clamp Stop Motion Clamp Screw for 32619
263j	1546	Pressure Regulating Thumb Screw
301c	1546	Arm Rock Shaft Screw Centre (lower)
307c	1731	Feed Rock Shaft Screw Centre
315c	1731	Feed Bar Screw Centre
399a	1731	Hand Attachment Gear Cover Screw for 94052b
443c	1546	Arm Shaft Bushing Set Screw for 32616
453c	1731	Presser Bar Guide Bracket Set Screw for 32535
453c	1731	Thread Take-up Spring Regulator Set Screw
465k	1986	Oscillating Hook Bell Crank Stud Collar Set Screw for 1642b	(Obsolete)
SS528j	2399	Embroidery Hoop Clamping Bracket Screw for 96417 to 96421, 96423 and 96424
552k	4160	Darning Presser Needle Clamp Screw for 86493

ILLUSTRATED
LIST OF PARTS

FOR

CLASS 66K MACHINES

THE SINGER MANUFACTURING COMPANY

Half Size

3

PLATE 724

32677



32531



32620

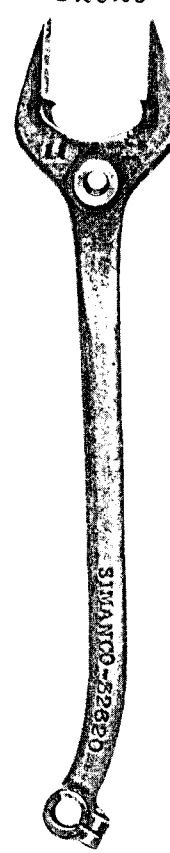

32676



From the library of: Diamond Needle Corp

32602

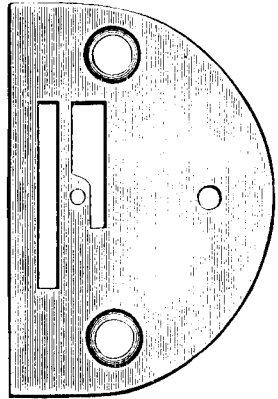

32600

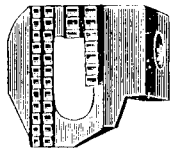

120842



120290

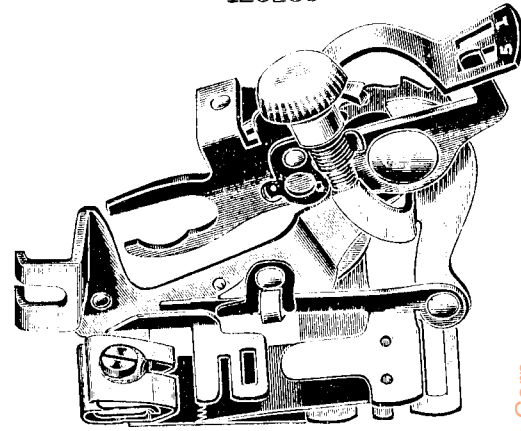

121464

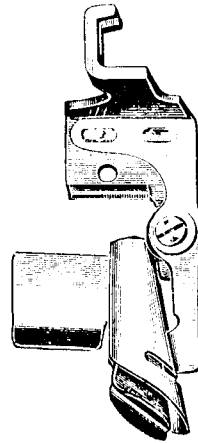

35931

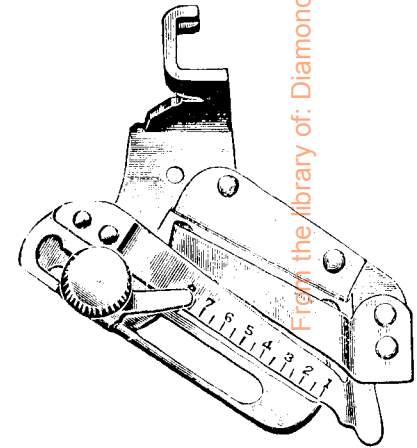

35932

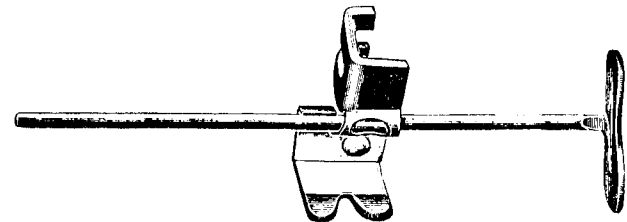

From the library of: Diamond Needle Corp

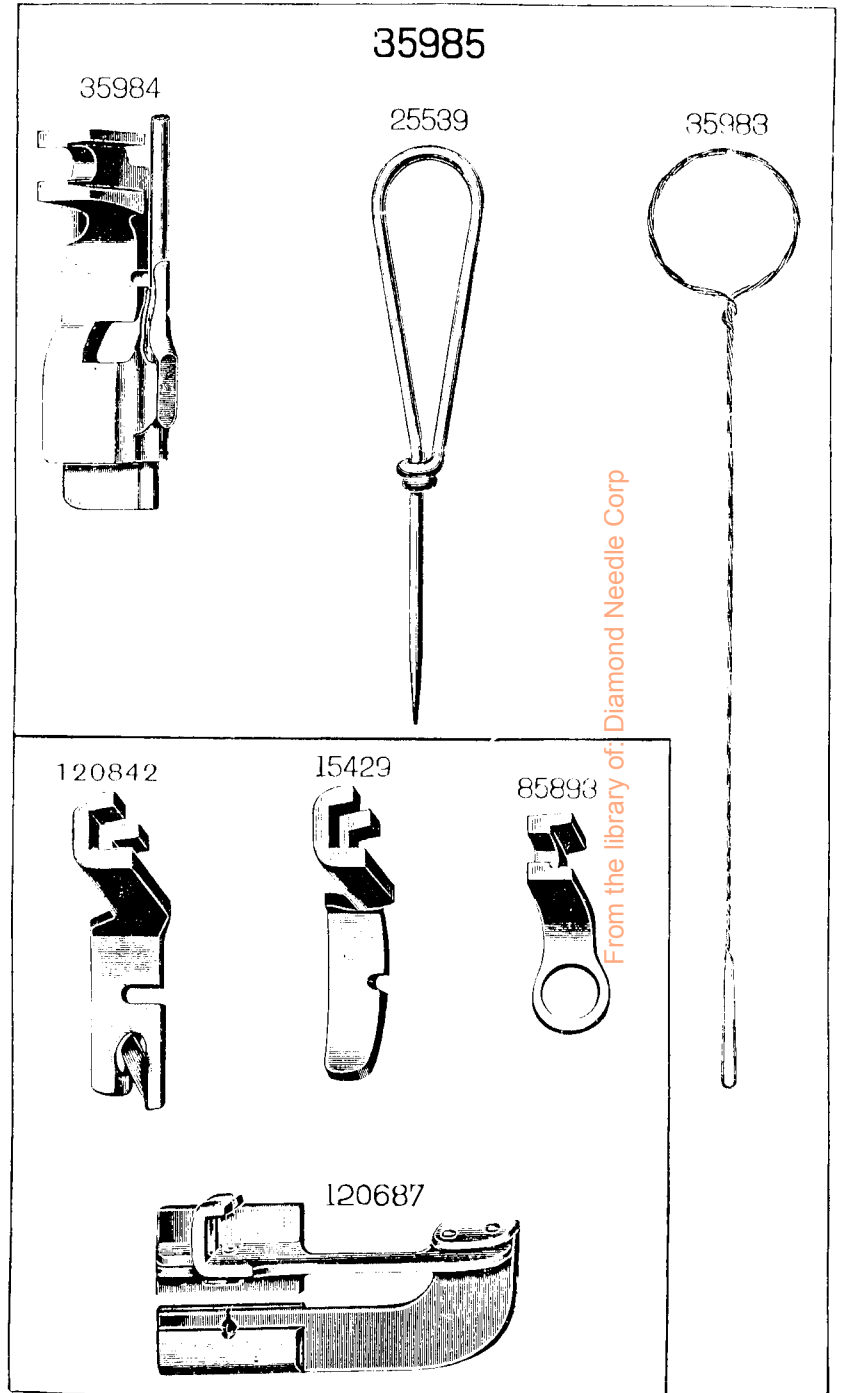
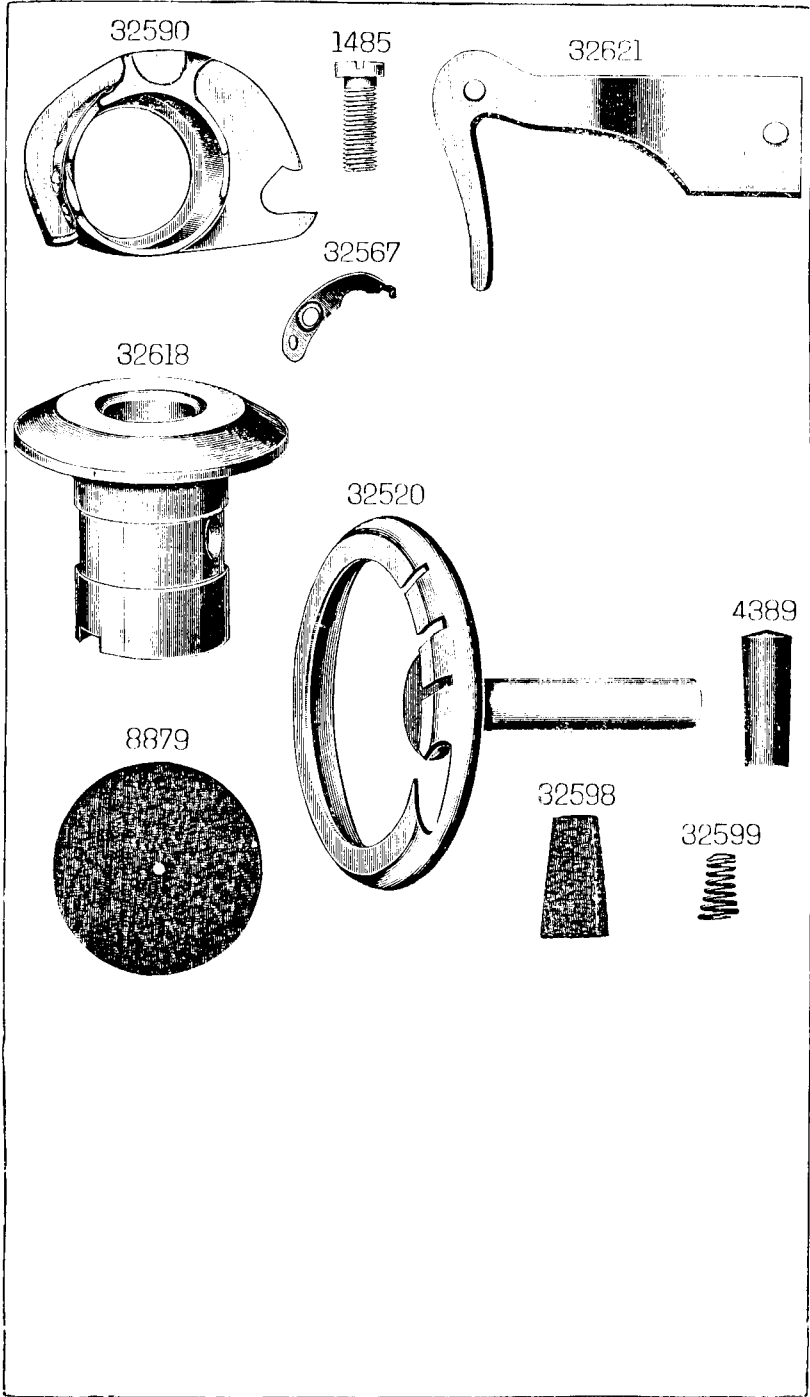

15282

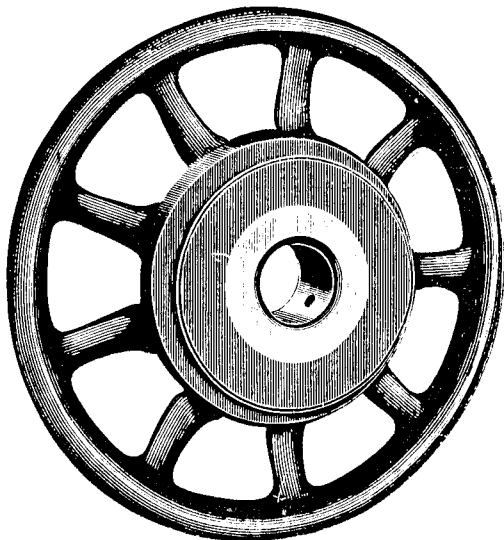

86496

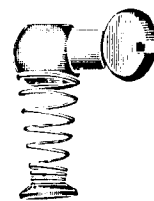

86493



86494



86495



36583

552

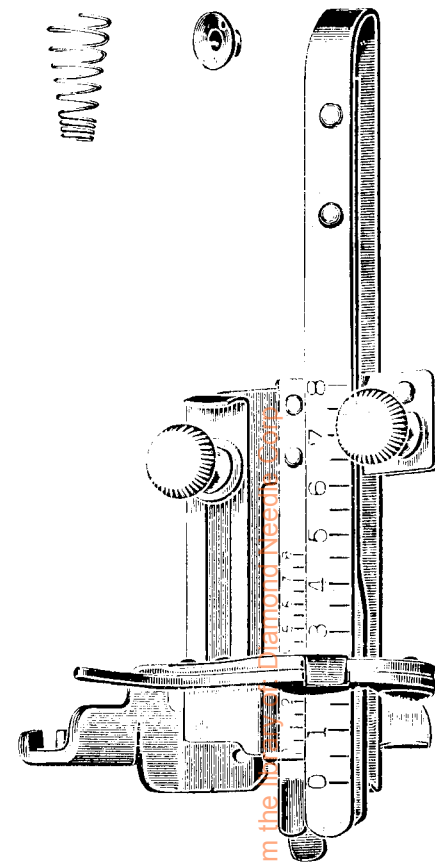

From the National Archives

87589

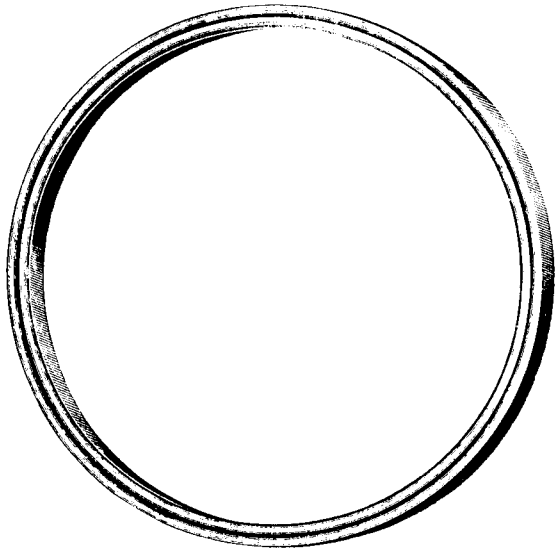

96422

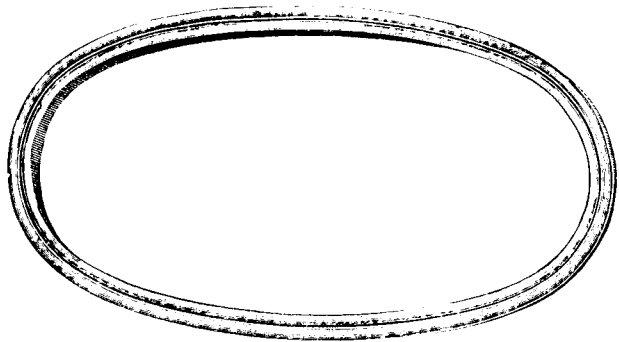

15376

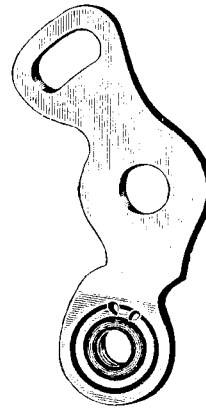

50230



32629

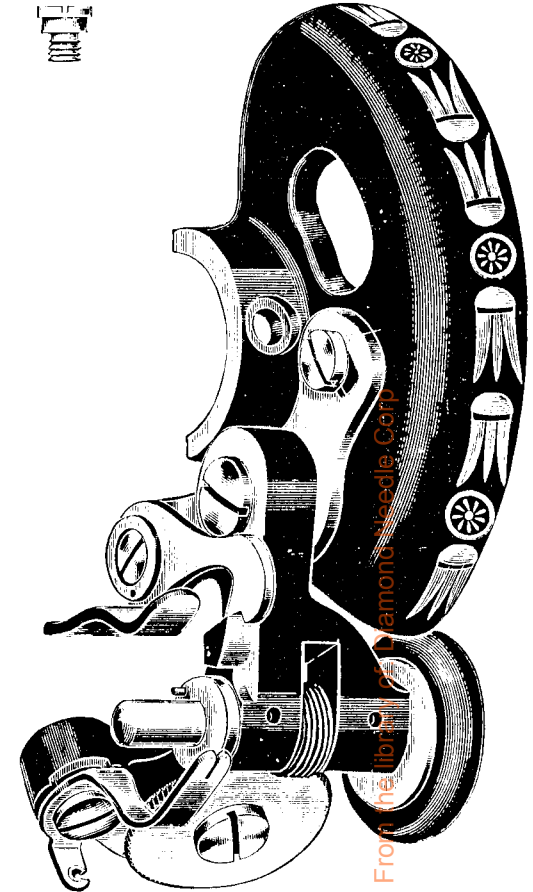

32625

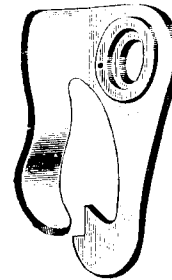

15413

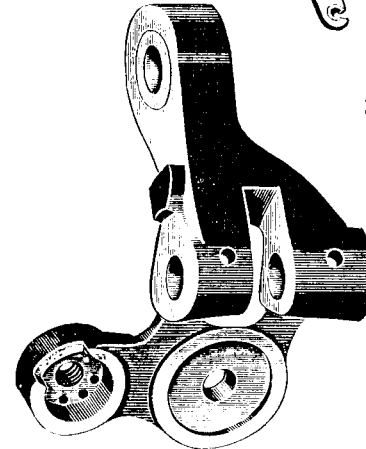

32623

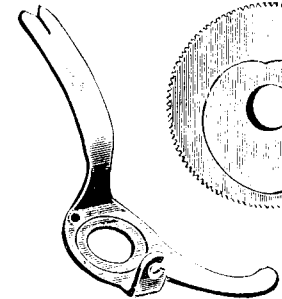

15415

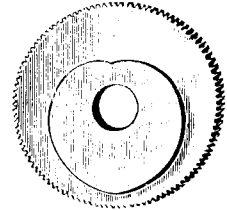

From the library of [Diamonds Seedle Corp.](#)

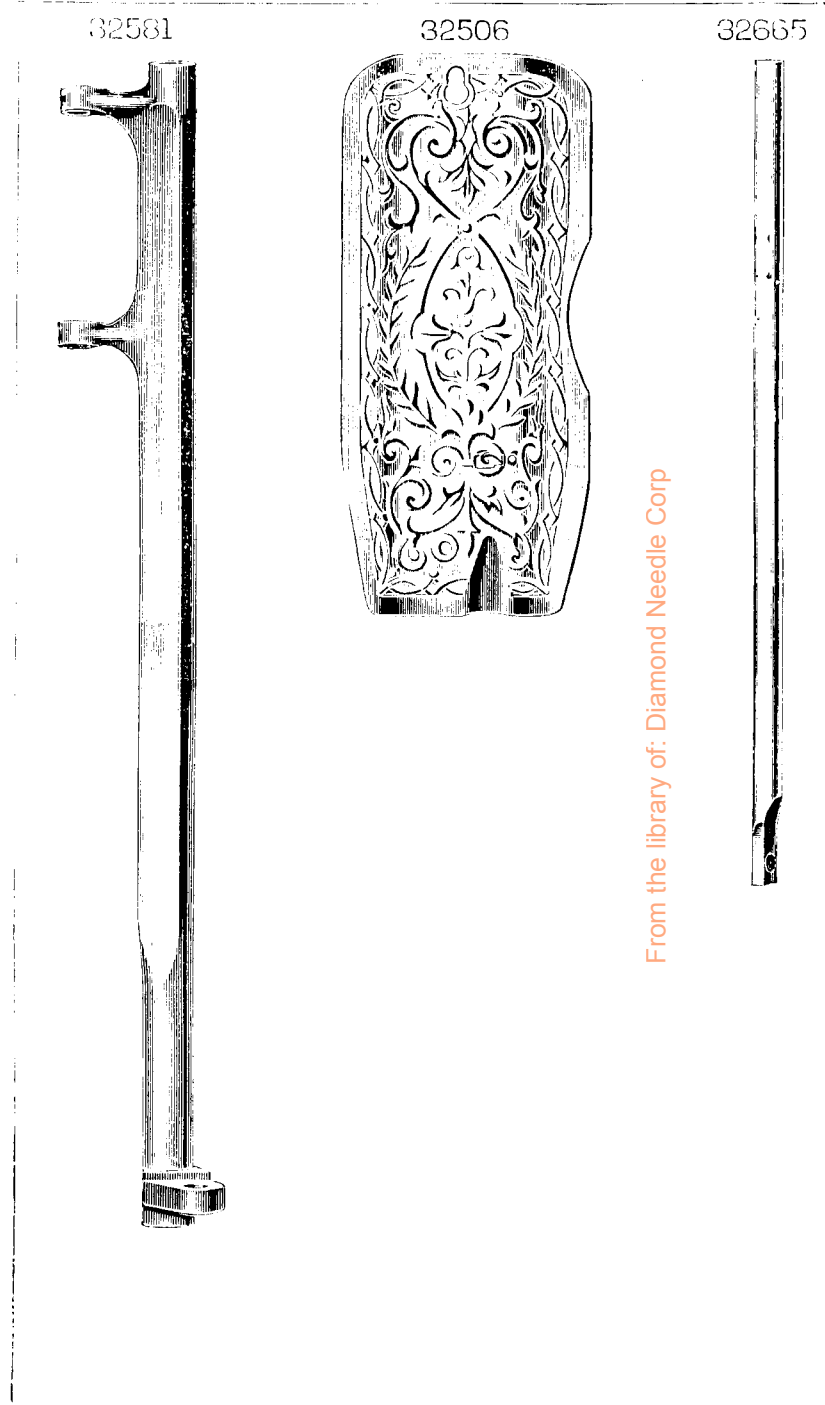
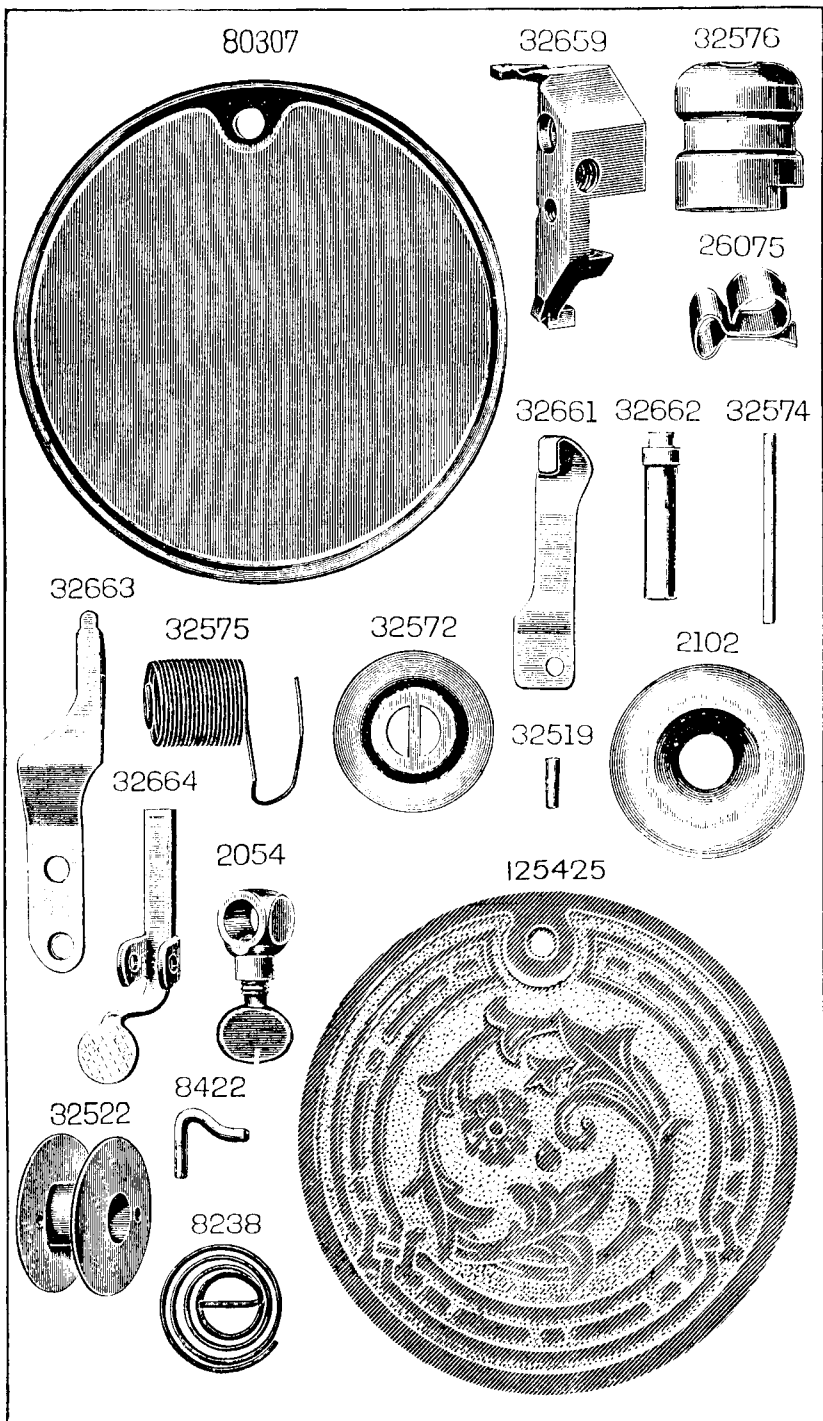

From the library of: Diamond Needle Corp

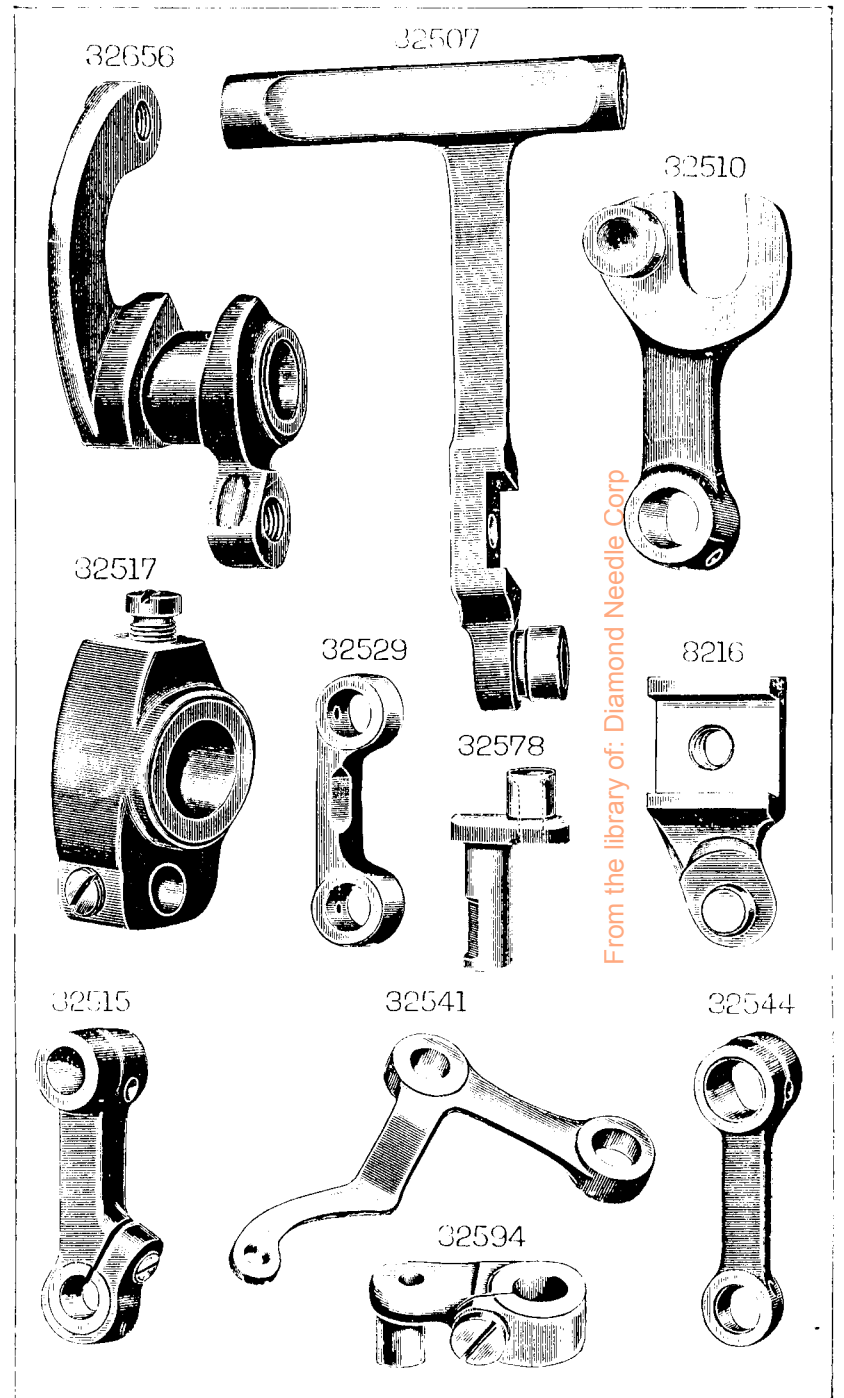
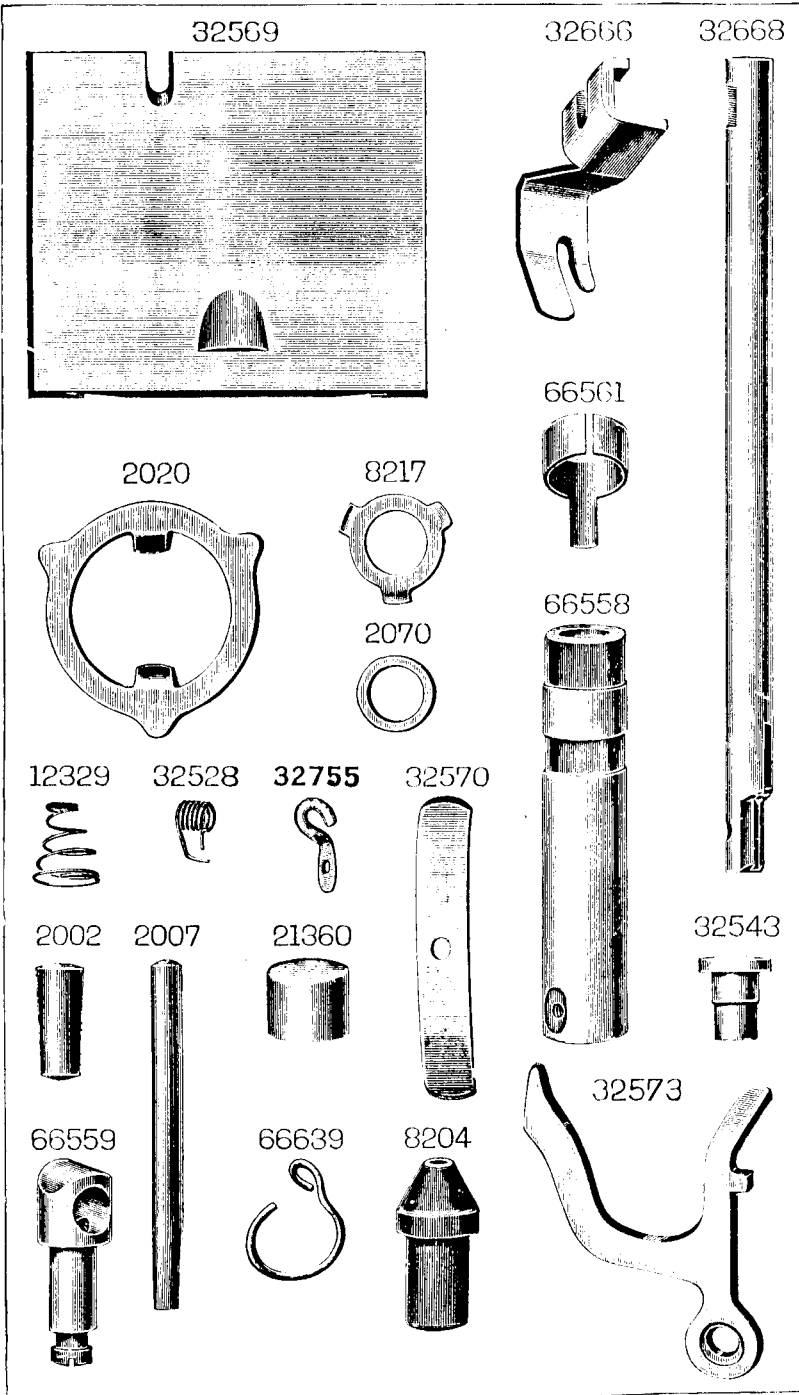

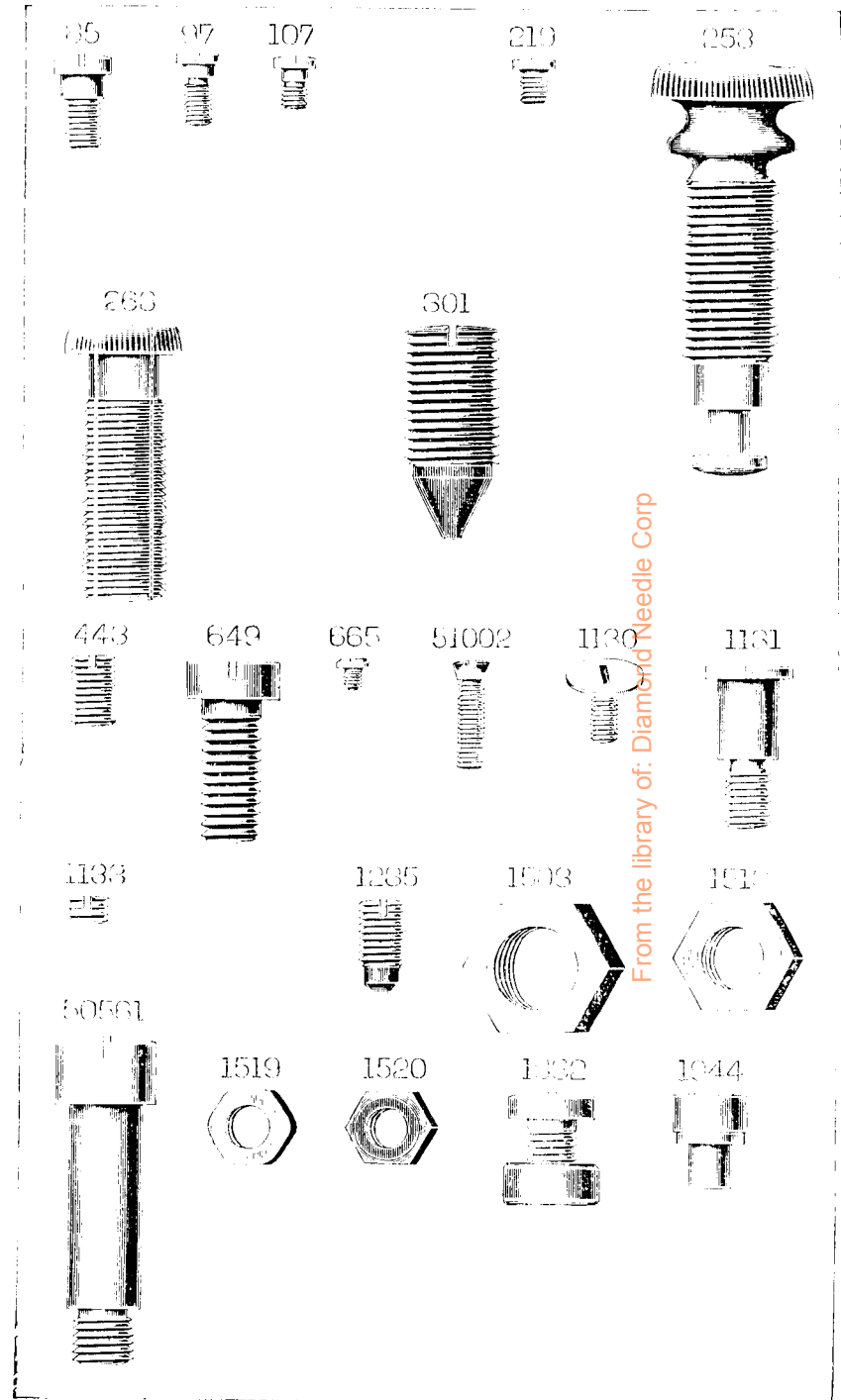
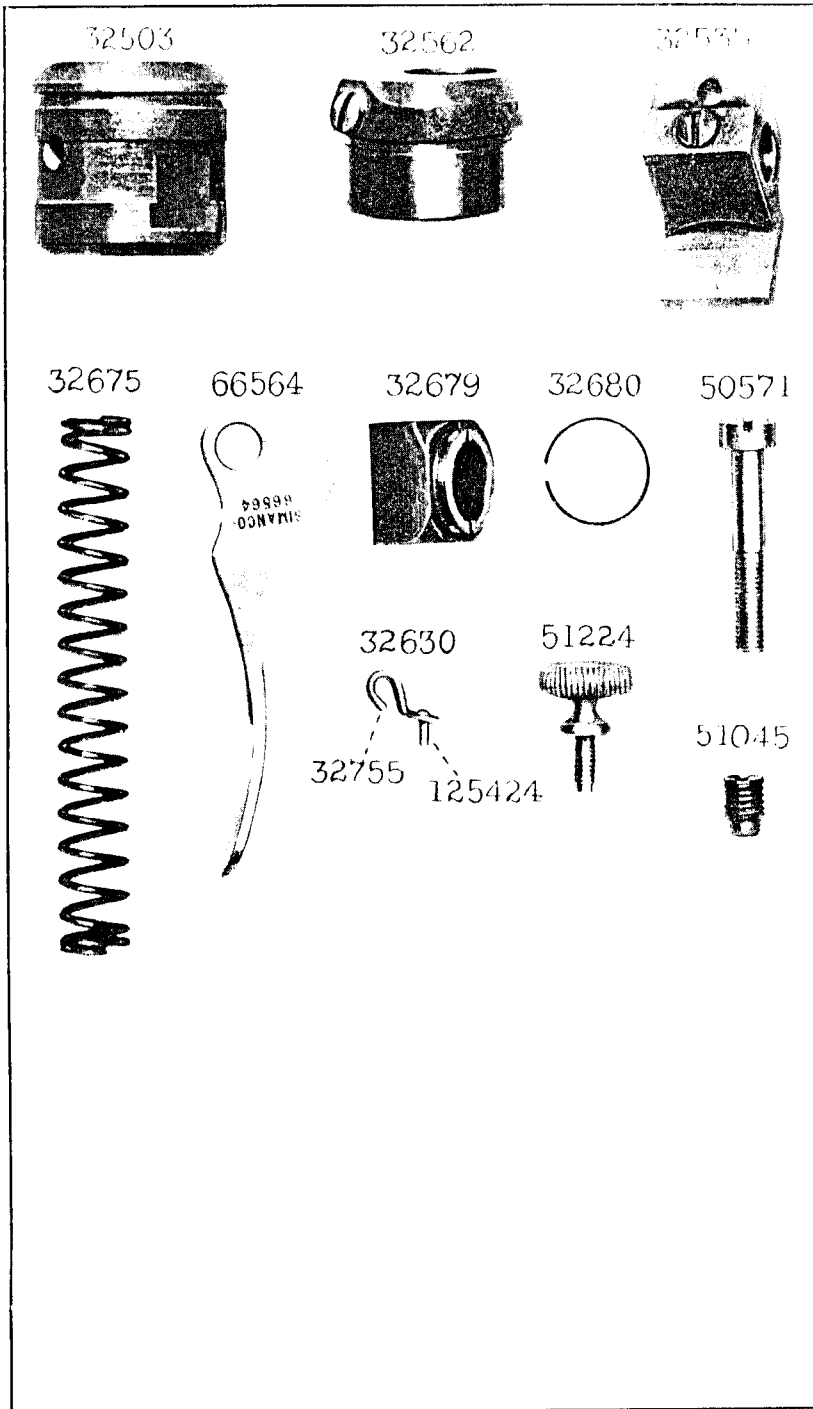

From the library of: Diamond Needle Corp

32550

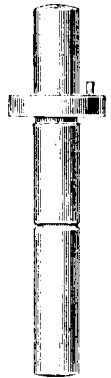

15288

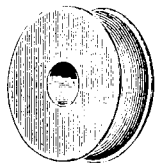

15287

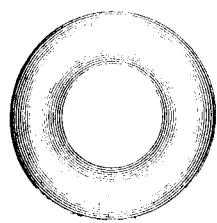

2749



15366



15291



15286



15072



50

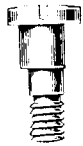

180



571



50058



50059



50061



1528



32672

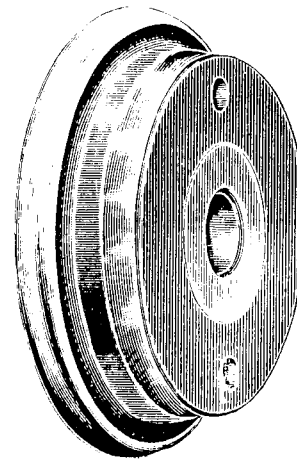

From the library of: Diamond Needle Corp

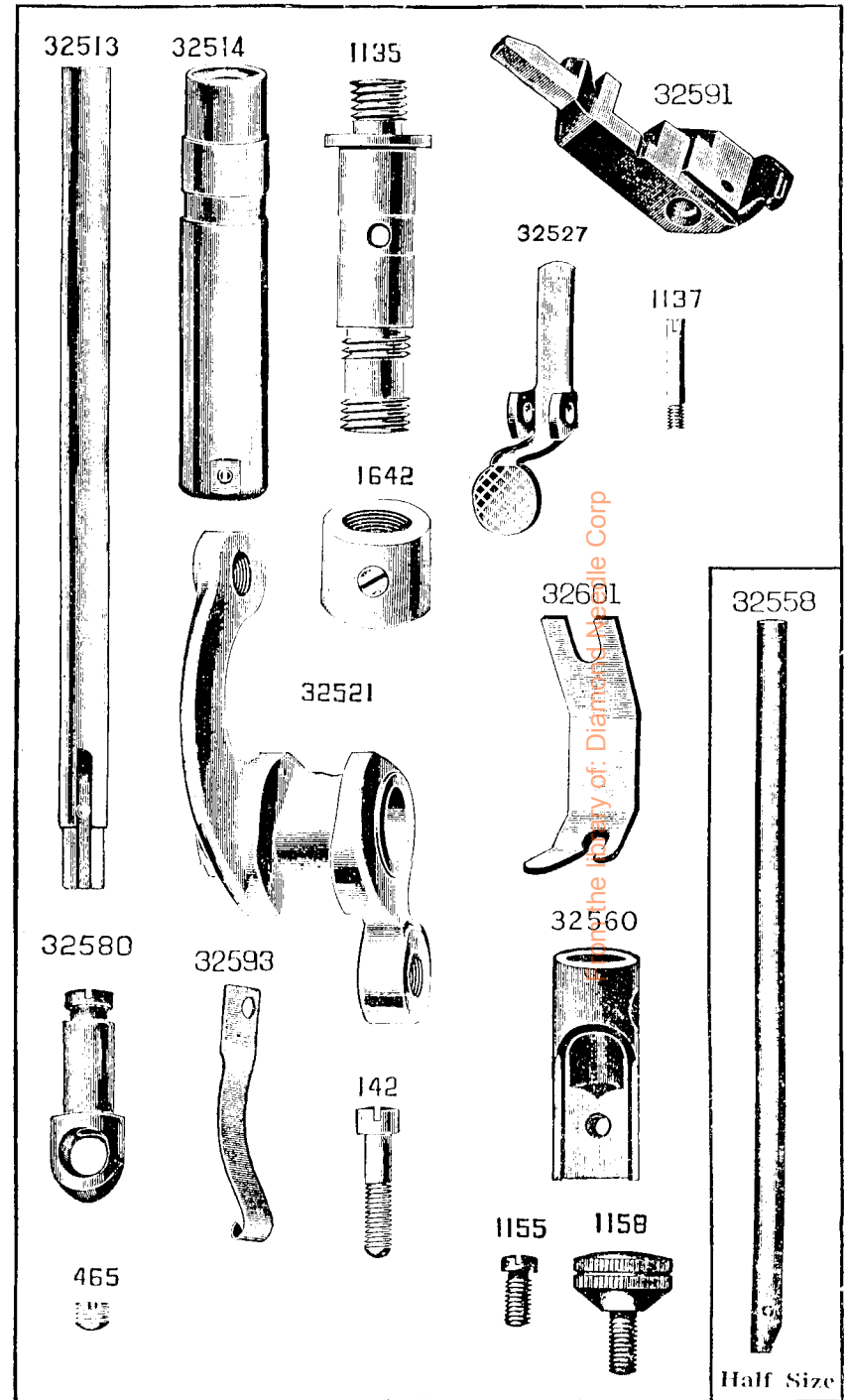
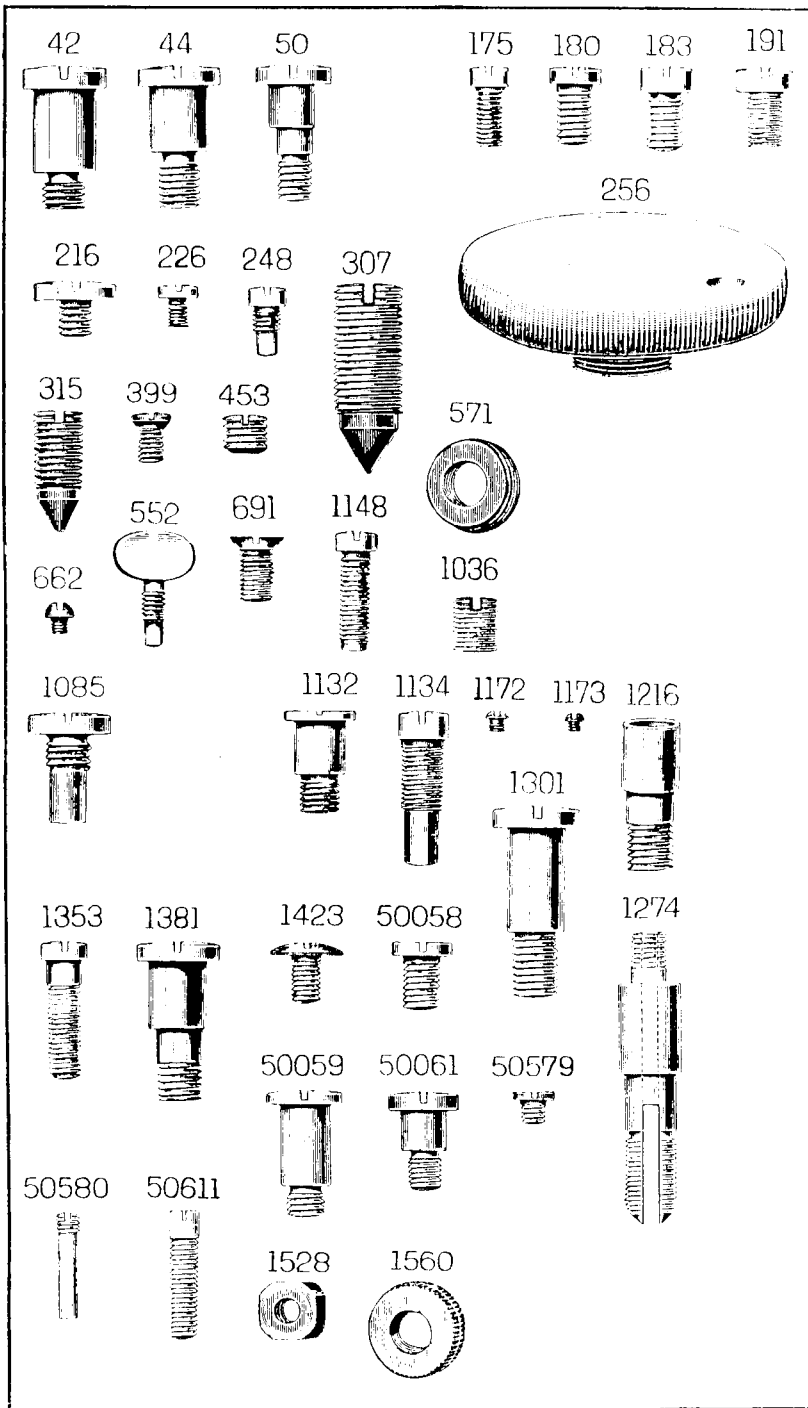

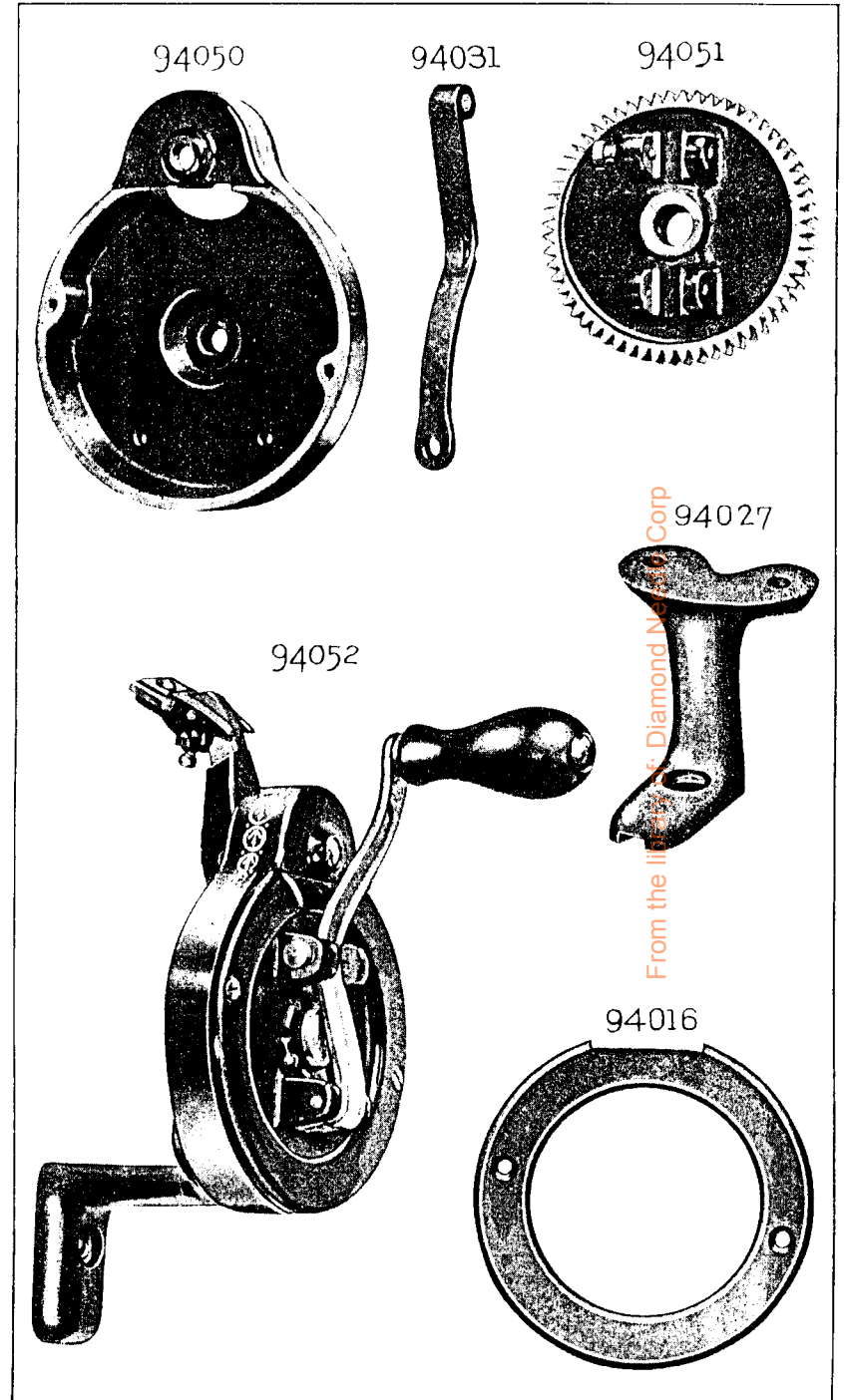
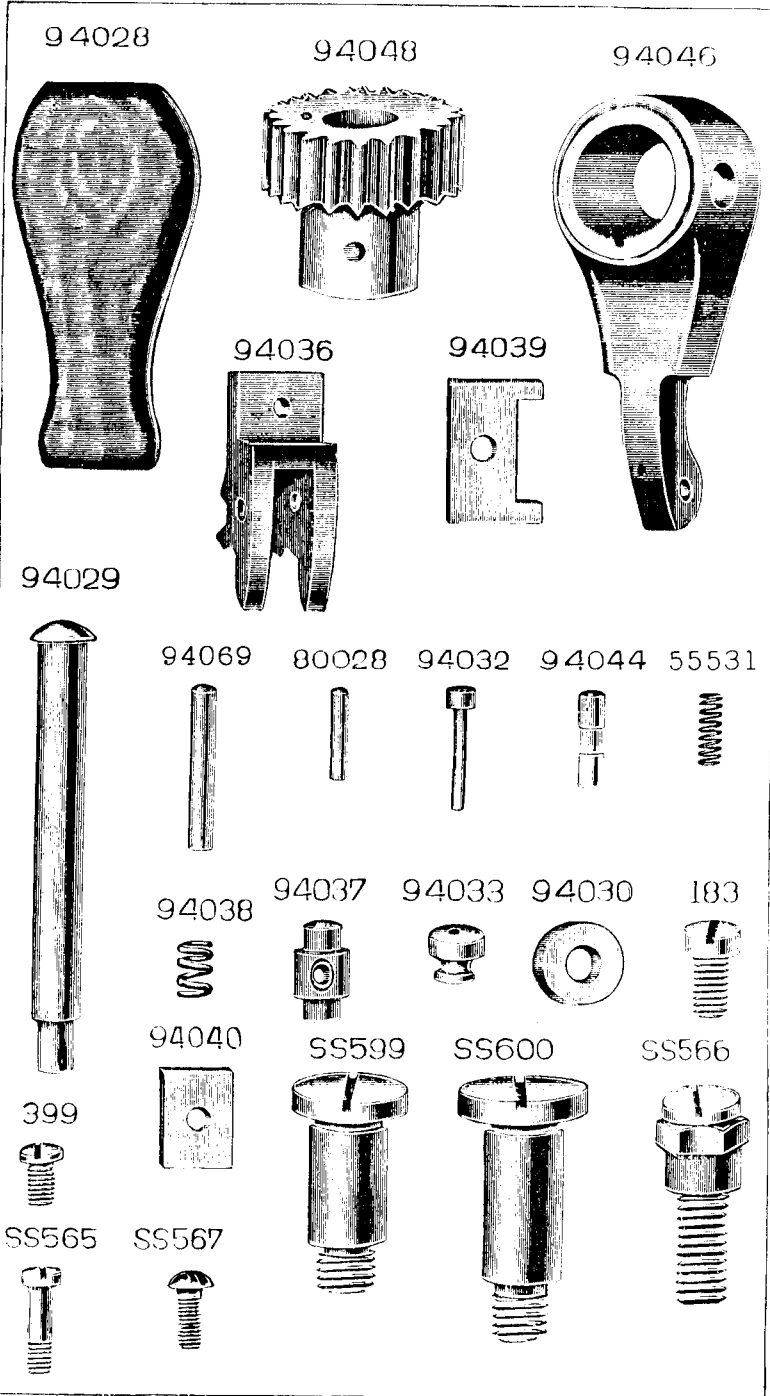

From the files of Diamond Manufacturing Corp

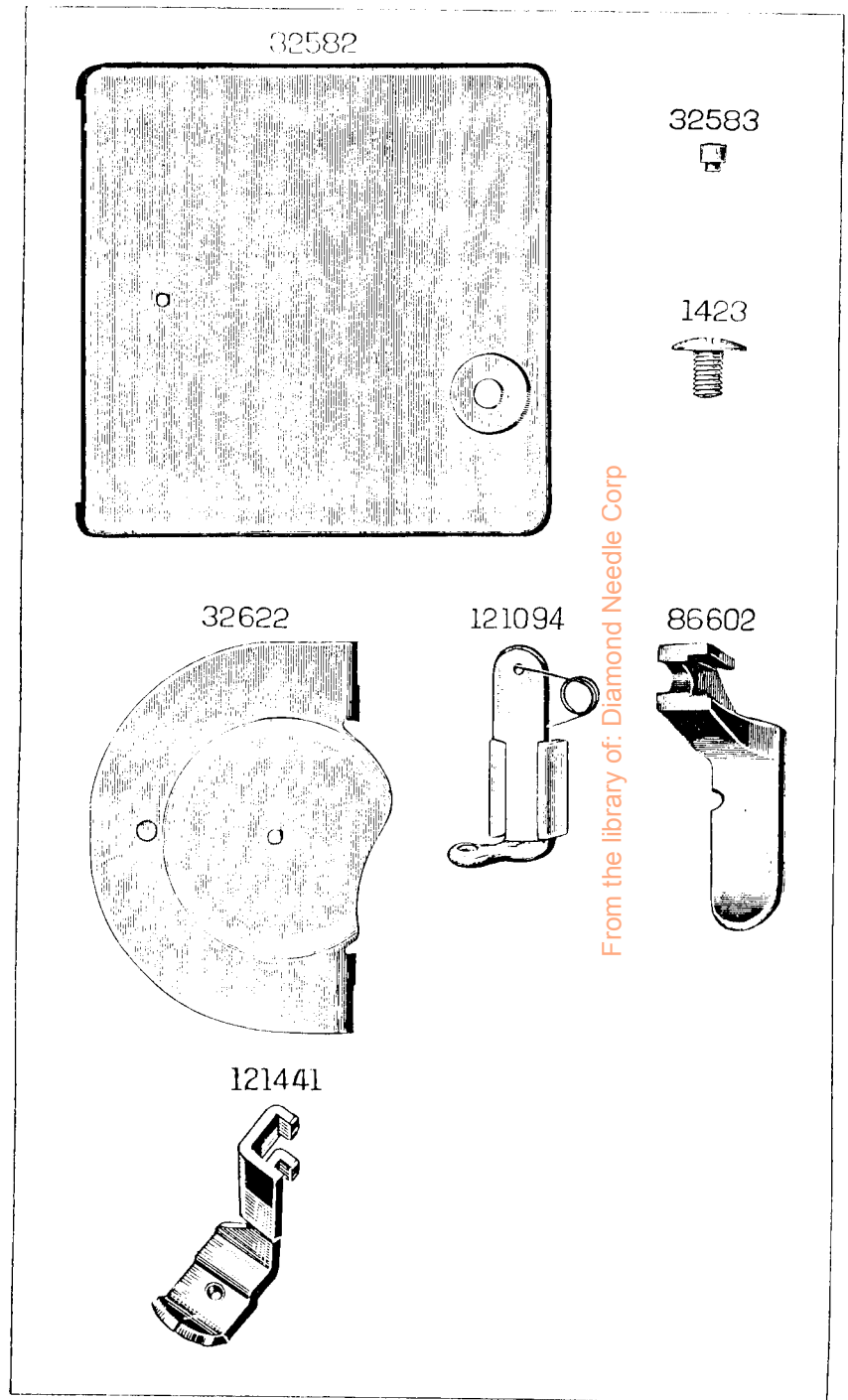
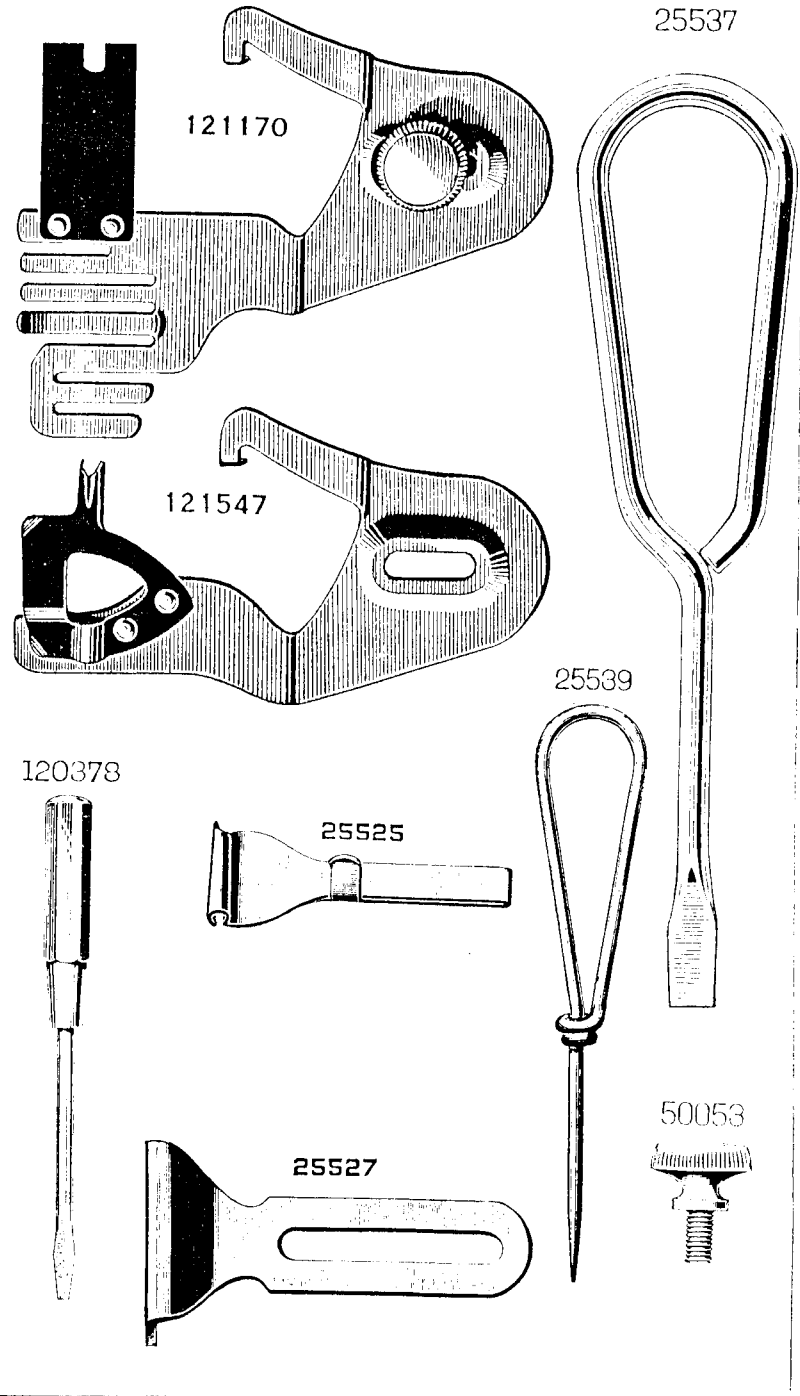

From the library of: Diamond Needle Corp

SS528



96425



96426



96844

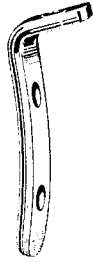

96427



96845



WV95

